

Varenummer: 4395001101  
Beskrivelse: Rota-fix spændelement F110x155  
Rustfast stål

## Mål

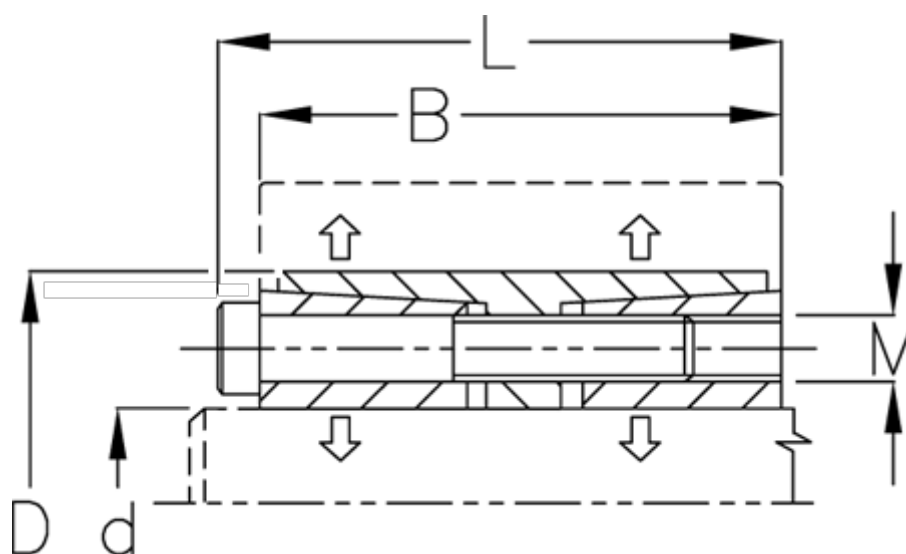

B mm	= 102
d H8 mm	= 110
D mm	= 155
F kN aksialkraft	= 316.0
L mm	= 114
M mm	= M12
Overfladeruhed	= R? ? 3.2 $\mu$ m
P N/mm <sup>2</sup> fladetryk på aksel/nav	= 37

T Nm drejningsmoment	= 17300
Tolerance	= Aksel h8, Nav H8
Ts Nm boltetilspændingsmoment	= 100.0